

User Guide : Sound Suite Demo Kit

RYDIS

Contents contained in this presentation are considered privileged and confidential information. Communications. Any reproduction of this presentation without the consent of Rydis Co, Ltd. Is strictly prohibited.

E : sales@rydis.co.kr

■ Supported Model

Years	OLED	MRGB	QNED
2025	G5, C5, CS5	-	-
2026	W6, G6, C6, CS6, B6, B6E	MRGB95/9M/85 (96, 95M, 9M, 91, 89, 88, 87, 86, 85, 83)	-

- This guide is intended for online distribution. A printed version will be produced separately and included in the package.



To ensure a stable demo environment and optimal sound experience, please follow the guidelines below before installing the demo kit.

TV Configuration

- Please set the TV to Store Mode.
- Please turn off the Wi-Fi option in the TV settings. (If Wi-Fi is enabled, it may take a long time when launching the app.)

Sound Suite Demo Rack Configuration

- Be sure to set Sound Suite (M5/M7/W7/H7) to Demo Mode. (Refer to page 7, "How to Set Up Demo Mode")
- Sound Suite (M5 or M7) must be used as a pair. (A mixed pair of M5 and M7 is not supported.)
- When entering Demo Mode, the EQ is automatically set to Standard. However, outdated information may be displayed in the ThinQ app.

External Control

- To ensure a smooth demo experience, the use of a remote control is not recommended.

Power Connection

- When using a power strip, please use a product supported for 16A.
- Audio can still be output even if the USB controller adapter is not powered. However, for stable operation, please ensure that power is supplied.

Others

- The TV will automatically switch to Store Mode when connected to the webOS demo app.

Table of Contents

1. Components
2. STEP 1. Main Demo Kit Connection
3. STEP 2. Sound Suite Connection
4. **How to Set Up Demo Mode**
5. Connection Diagram
6. Operation Scenario
7. Keypad Button Functions
8. **How to Deactivate Demo Mode**
9. Contact

Demo Kit Components

Keypad

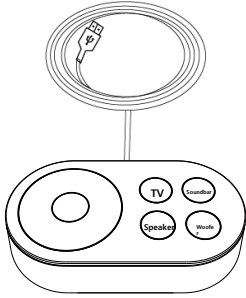

2. UAC Player (1 unit)

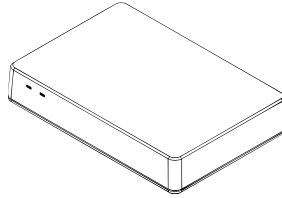

3. USB Controller (1 unit)

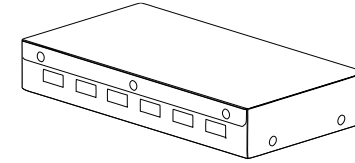

Accessories

USB Memory
(WebOS Demo App)

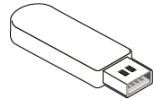

USB Type-C Power Adapter
(for UAC Player)

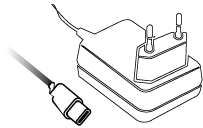

USB A to B cable x 1 ea
(for UAC Player and USB Controller)

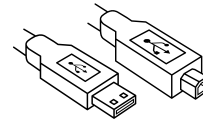

LAN cable 3M x 1 ea
(for TV and UAC Player)

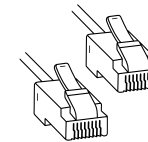

User Guide

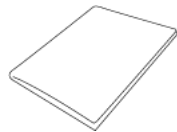

DC Power Adapter
(for USB Controller)

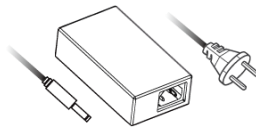

USB A to C cable 3M x 5ea
(for USB Controller and UAC speaker)

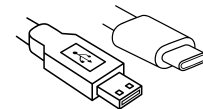

If any components are missing, please contact us using the information below.

- E-mail : rydis1@rydis.co.kr
- TEL : +82-70-8671-2210

Connection UAC Player & USB Controller

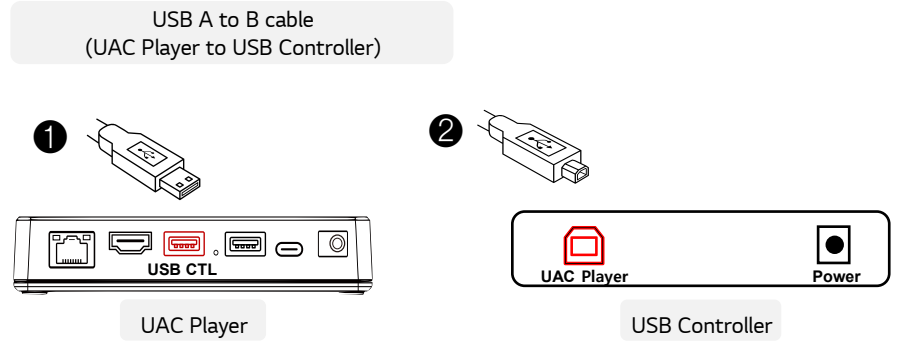

- ① Connect the USB A end of the A-to-B cable to the [USB CTL] port on the UAC Player.
- ② Connect the USB B end of the A-to-B cable to the [UAC Player] port on the USB Controller.

Connection Keypad

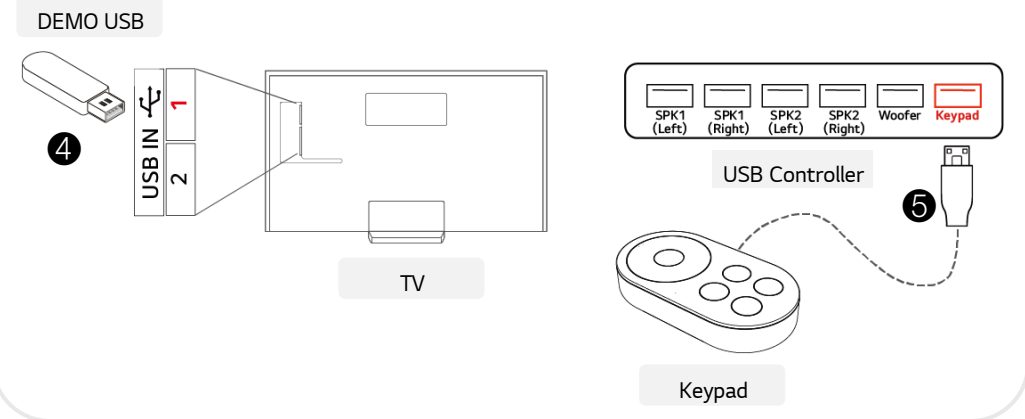

- ④ Connect the USB memory (webOS Demo App) to USB port 1 on the TV.
- ⑤ Connect the cable from the button keypad to the [Keypad] port on the USB Controller.

Connection UAC Player & TV

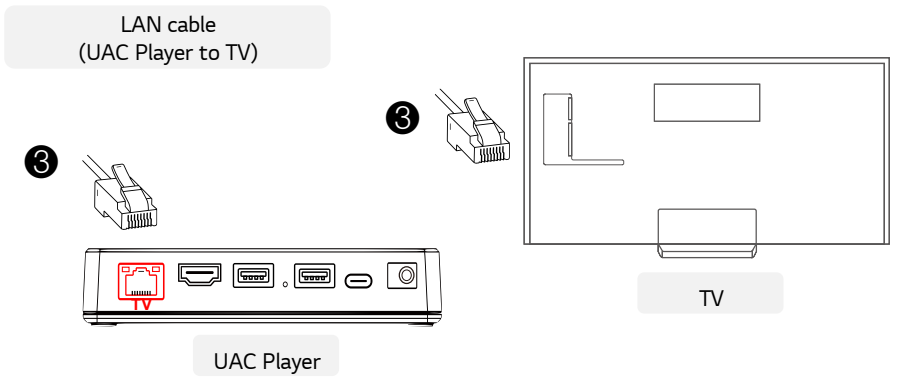

- ③ Connect the LAN cable to the [TV] port on the UAC Player and the [LAN] port on the TV.

Connect the speaker power & Set the Speaker Demo Mode

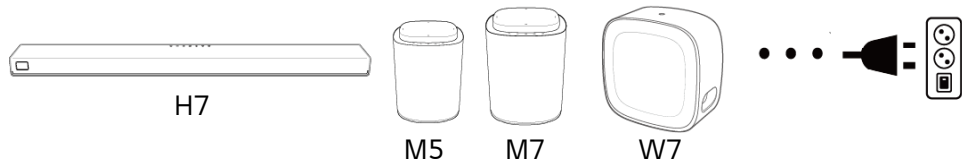

- ① Connect power to the M5/M7/W7/H7.
- ② Please refer to next page and set the M5/M7/W7/H7 to Demo Mode.

Connect H7 & TV

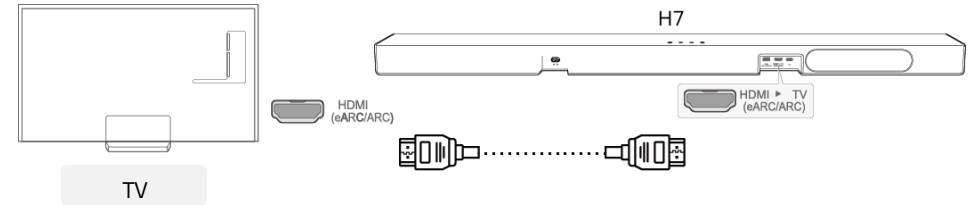

- ④ Connect power to the M5/M7/W7/H7.
Please refer to next page and set the M5/M7/W7/H7 to Demo Mode.

Connect the speaker & USB Controller

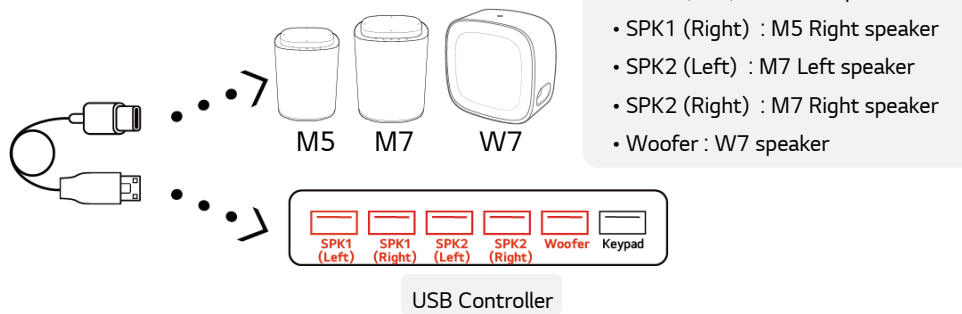

- ③ Connect the USB Controller and the M5/M7/W7 using an A-to-C cable.
(Connect the M5/M7/W7 in the specified order according to the labeled on the USB Controller ports.)

Connect the Demo Kit power

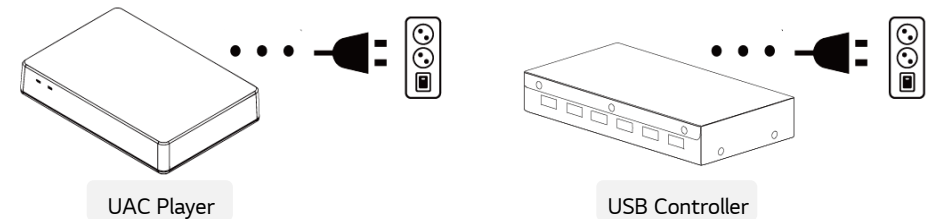

- ⑤ Connect the UAC Player to power using the dedicated adapter.
Connect the USB Controller to power using the dedicated adapter.

4. How to Set Up Demo Mode

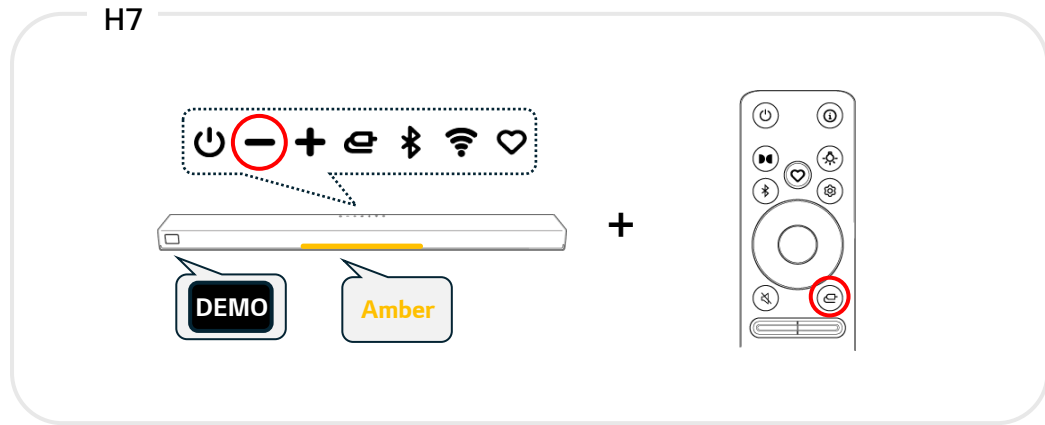

Press and hold the H7 [—] button and the remote control [⏪] button simultaneously for 5 seconds.

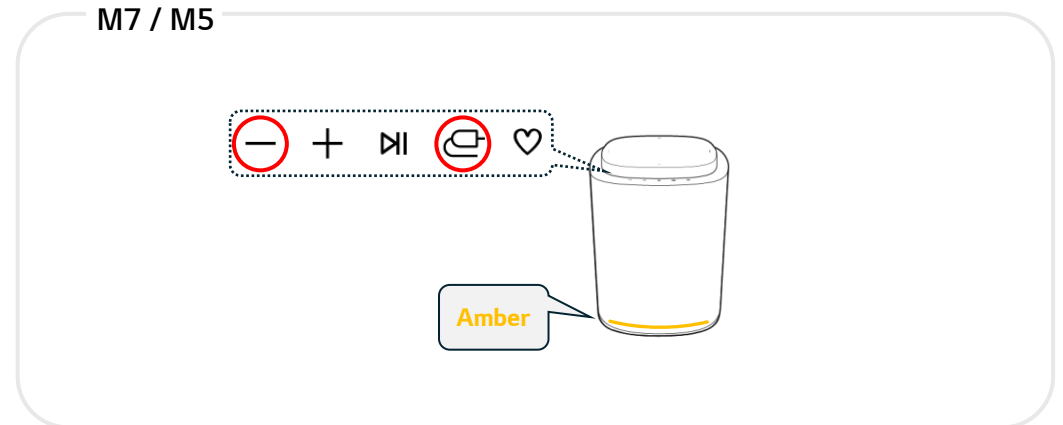

Press the [—] and [⏪] buttons simultaneously for 5 seconds.

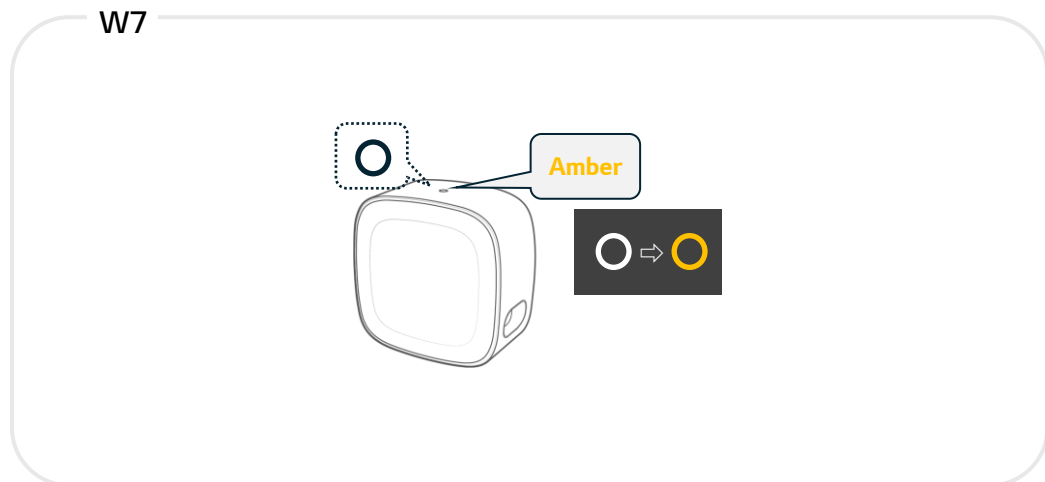

Press the [○] button more than 10 times within 3 seconds until the LED color changes.

Demo Kit Connection Diagram

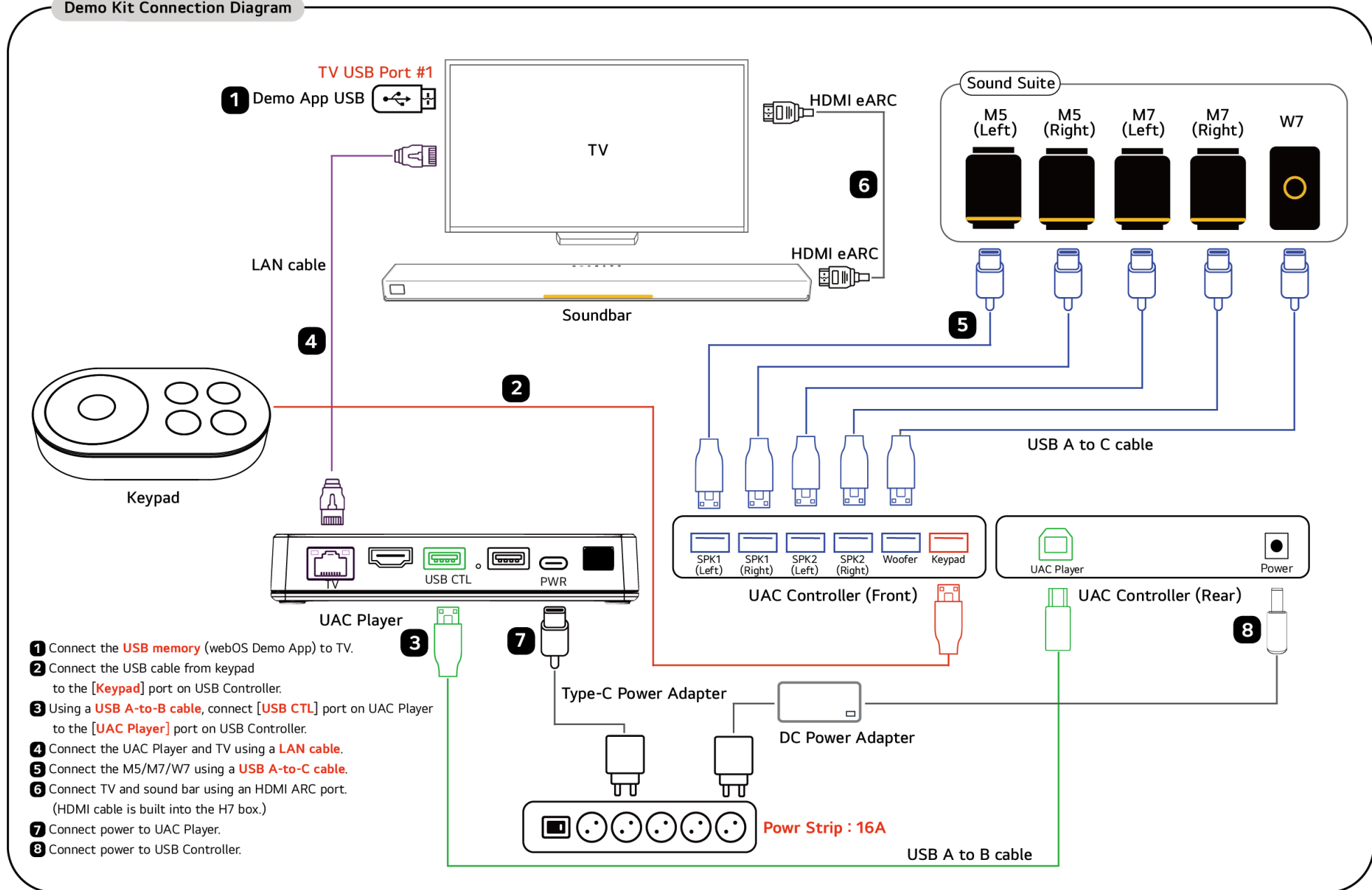

- 1** Connect the **USB memory** (webOS Demo App) to TV.
- 2** Connect the USB cable from keypad to the **[Keypad]** port on USB Controller.
- 3** Using a **USB A-to-B cable**, connect **[USB CTL]** port on UAC Player to the **[UAC Player]** port on USB Controller.
- 4** Connect the UAC Player and TV using a **LAN cable**.
- 5** Connect the M5/M7/W7 using a **USB A-to-C cable**.
- 6** Connect TV and sound bar using an HDMI ARC port. (HDMI cable is built into the H7 box.)
- 7** Connect power to UAC Player.
- 8** Connect power to USB Controller.

1. Run the App

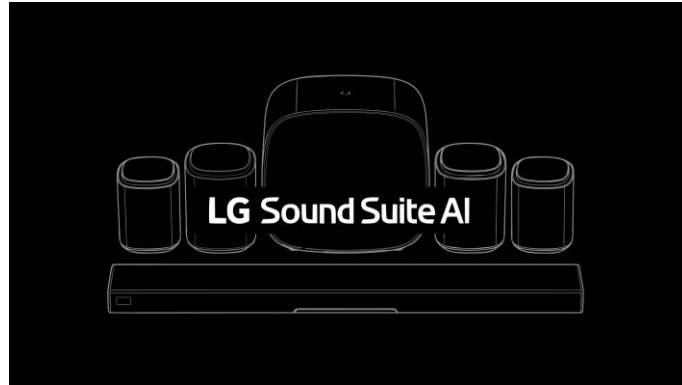

1. When the TV is turned on, the demo app runs automatically (on first launch).

2. App Loading

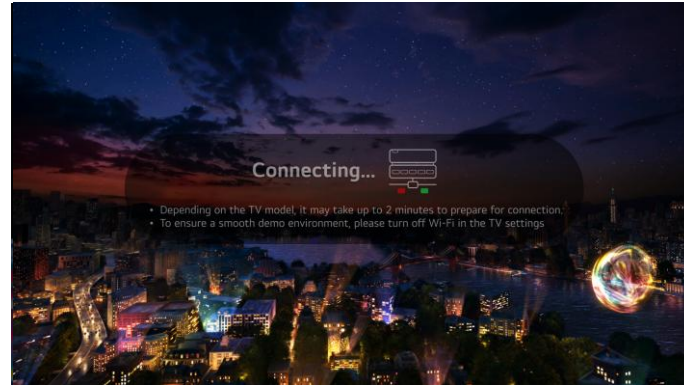

1. "Connecting..." pop-up is displayed
 - Approximately 120 seconds on first launch.
 - Turn off Wi-Fi in the TV settings in advance.

3. IDLE Mode : Store Video Playback Status

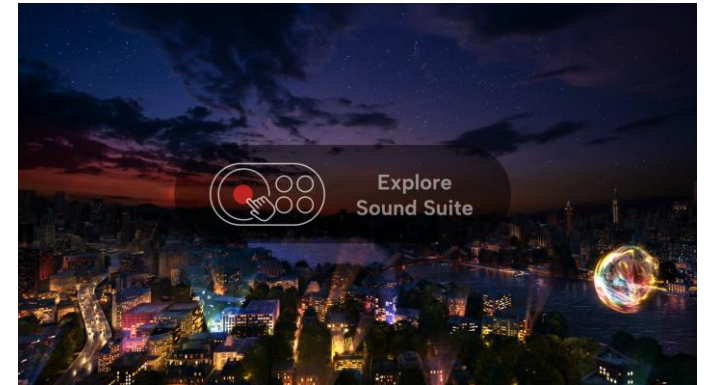

1. Once the TV model is recognized, the corresponding video will automatically play.
2. Volume is set to "0,"
3. Experience prompt pop-up is displayed every 20 seconds.

4. DEMO Mode : Video Selection Playback



1. Enter demo mode by selecting the keypad button.
2. Africa Unseen video playback starts.
3. Audio output: Soundbar + Speaker + Woofer
 - Default Volume: "20"

4. DEMO Mode : Switch Audio Output



1. Volume Control: Adjustable in increments of 5
2. Audio Output Selection:
 - TV ↔ Sound Bar (switchable) / Speakers & Woofer (On/Off)
3. Bottom UI Display:
 - [TV or Soundbar] / [Speakers and Woofer] status
 - Keypad selection status

Demo Mode Behavior

1. Press the keypad button to display the content selection menu.
2. Screen display time: 15 seconds
(The menu disappears immediately when a thumbnail is selected.)
3. After entering demo mode, the Africa Unseen plays automatically.
 - Audio Output (Default) : Soundbar + Speaker + Woofer
 - Default Volume : 20

Default Audio Output by Content

- Cosmos, Africa Unseen : Soundbar + Speakers + Woofer
- USP Video : TV + Speakers + Woofer

Returns to Idle Mode

- Returns to idle mode after 60 seconds of inactivity.

DEMO Mode : Playback Demo Contents

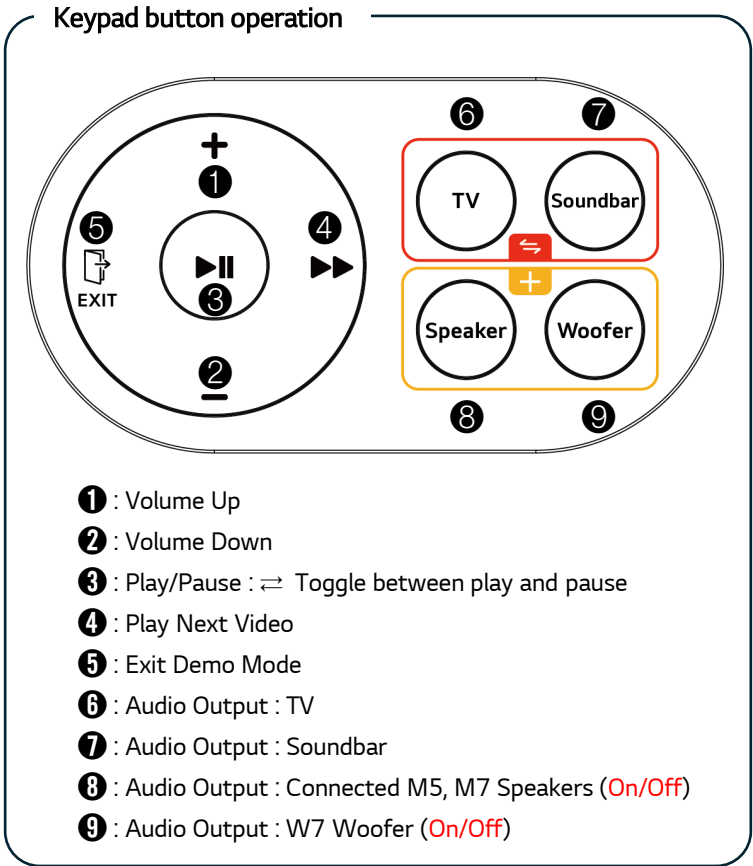

① TV - Soundbar Output Switching

- Displays the current output status (TV ↔ Sound Bar)

② Keypad Status Display

- Displays the user's button selection status on the keypad

③ Speaker Status Display

- Displays connection status: Unconnected / Off / On

④ Woofer Status Display

- Displays connection status: Unconnected / Off / On

1. DEMO Mode : Playback Demo Contents [Africa Unseen / Cosmos]

Switching between TV and Soundbar

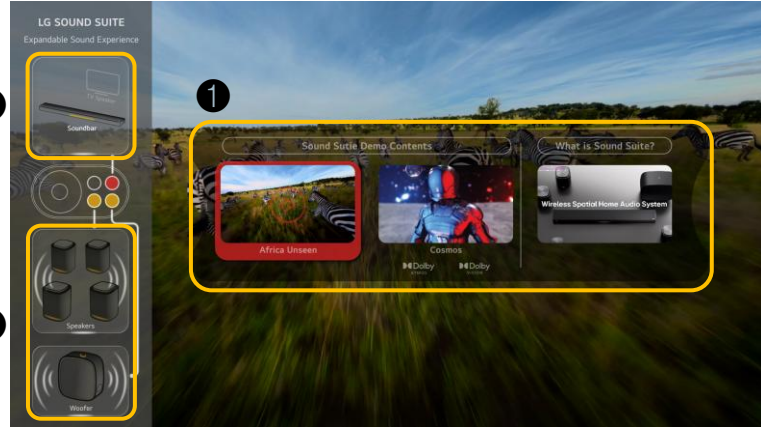

Entering Demo Mode

- In Idle state, press any keypad button to enter Demo Mode.

Default Audio Output

- Soundbar + Speaker + Woofer "On"

1 Contents Selection UI

- Press the [▶||] or [▶▶] button During Demo Video Playback.

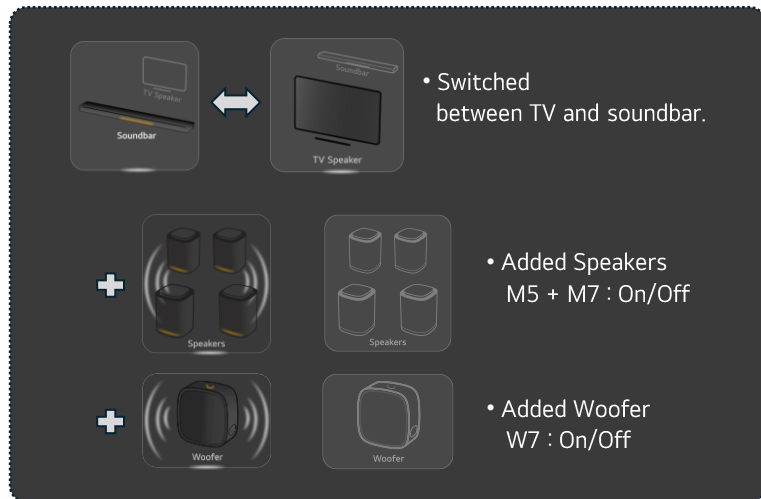

• Switched between TV and soundbar.

• Added Speakers M5 + M7 : On/Off

• Added Woofer W7 : On/Off

Case #1



Thumbnail Selection

- Select a thumbnail to play the selected video.

Control is transferred to the keypad

- The thumbnail screen disappears.

Case #3



• On : Soundbar, Woofer

• Off : Speakers

- Audio output can be switched between TV and soundbar.

- Speaker and Woofer can be turned on or off, as in Cases 1 to 4.

Case #2



• On : Soundbar, Speakers

• Off : Woofer

Case #4



• On : Soundbar

• Off : Speakers, Woofer

2. DEMO Mode : Playback Promotion Content [USP]

Promotion Video Playback



USP Video Playback

- When the USP video is selected:
 - Audio Output Status : Full Configuration Playback
 - The thumbnail menu and the left indicator disappears.

Case #1

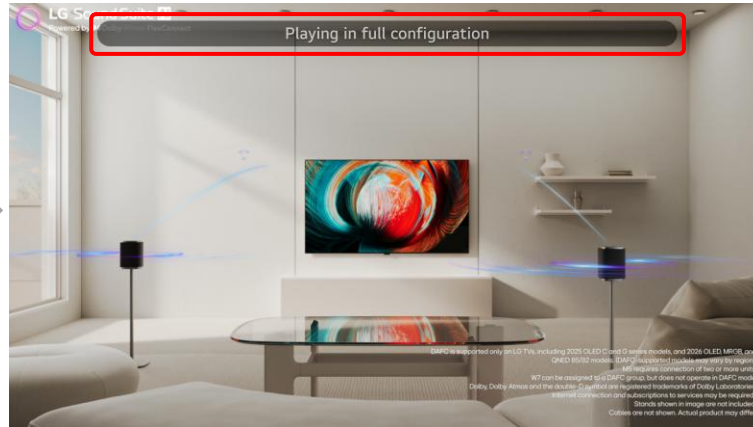

During playback:

- Audio switching and speaker and woofer selections are not available.
 - The four buttons on the right side of the keypad do not function.
- A pop-up is displayed at the top of the screen.
 - The pop-up appears when any of the four right-side buttons are pressed
 - Displayed for 3 seconds.

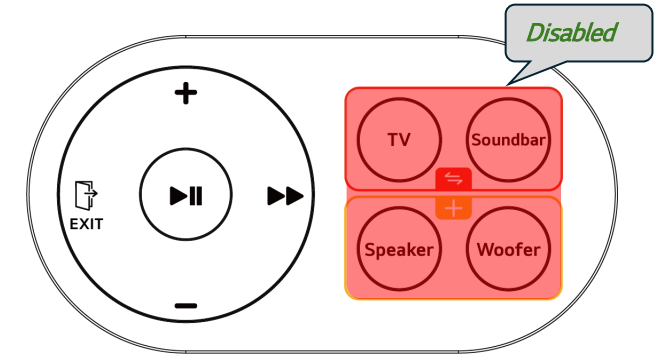

Converting Popup



“Converting to” pop-up appears

- when switching audio output from the TV to the soundbar in Demo Mode.

Connecting to a Non-Compatible TV

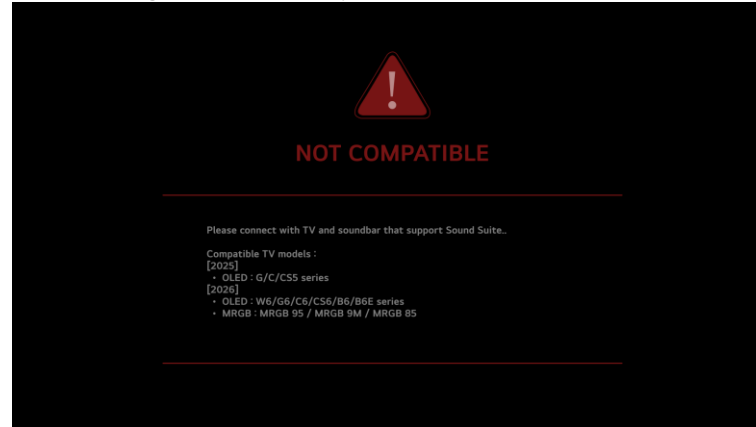

When connecting the Demo App USB to a Sound Suite–unsupported TV

Target TV Model :

[2025] OLED : G5/C5/CS5

[2026] OLED : W6/G6/C6/CS6/B6/B6E, MRGB : MRGB95/9M/85

System App Update



“Updating” pop-up will appear

- when the system app update USB is connected.
- The pop-up will disappear once the update is complete.

** The webOS demo app is updated by replacing the USB.*

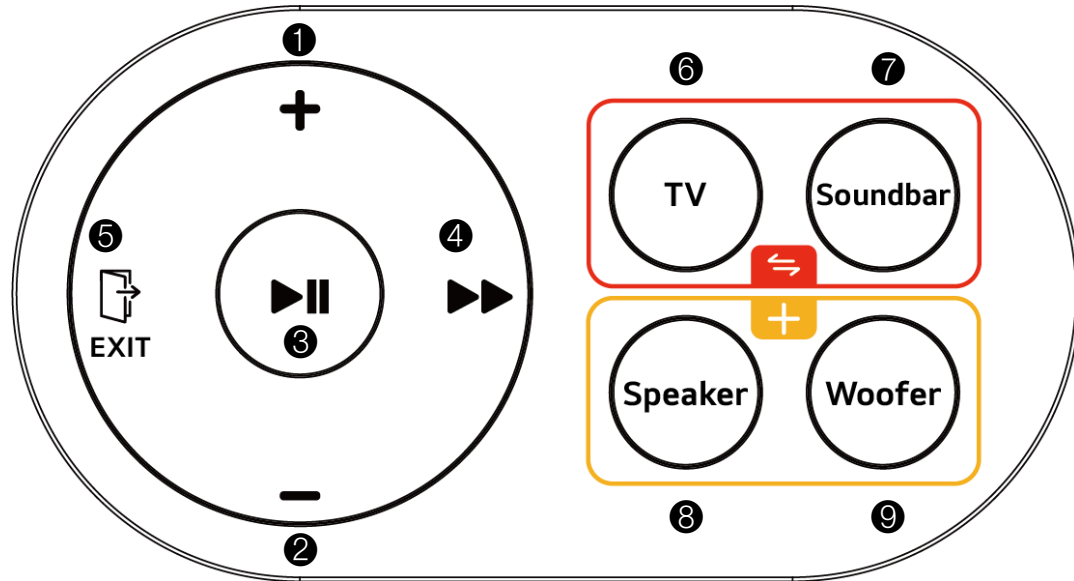

- ❶ : Volume Up
- ❷ : Volume Down
- ❸ : Play/Pause : Pauses during video playback ⇔ Toggle between play and pause
- ❹ : Playe Next Video
- ❺ : Exit Demo Mode
- ❻ : Audio Output : TV
- ❼ : Audio Output : Soundbar
- ❽ : Audio Output : Connected M5, M7 Speakers (On/Off)
- ❾ : Audio Output : W7 Woofer (On/Off)

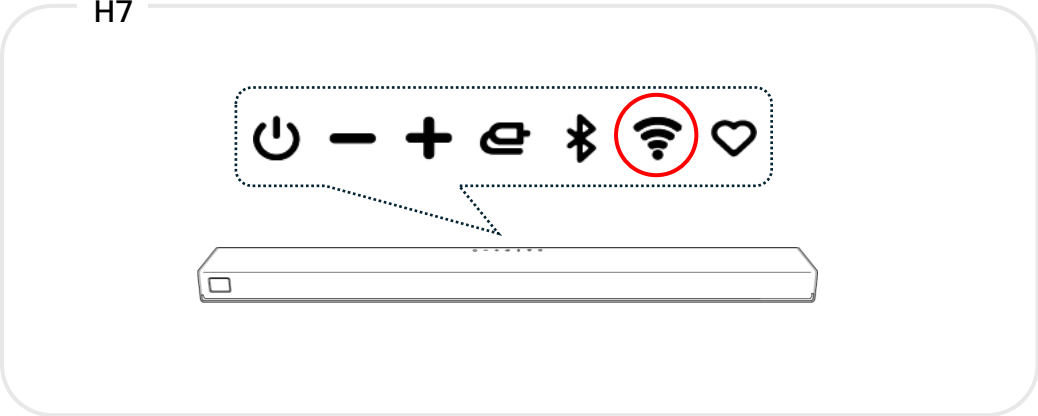

Press and hold the H7 [Wi-Fi] button for 5 seconds until the demo status LED disappears.

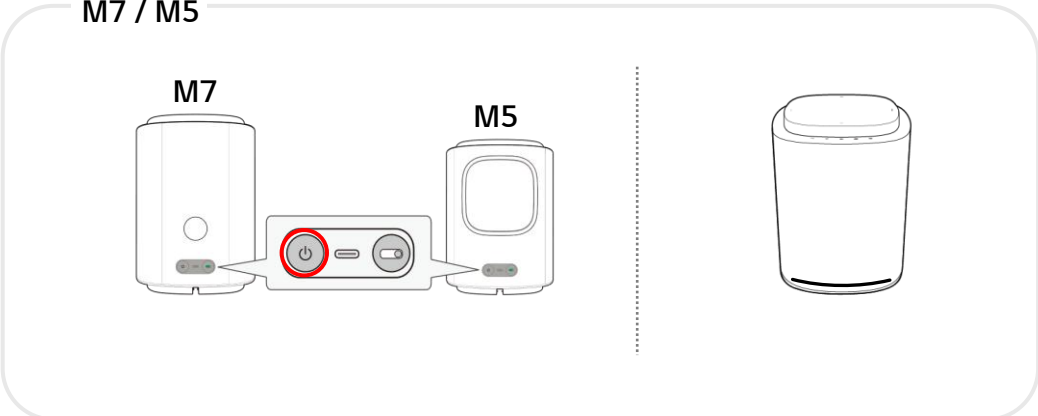

Press the [Power] for 10 seconds until the demo status LED disappears.

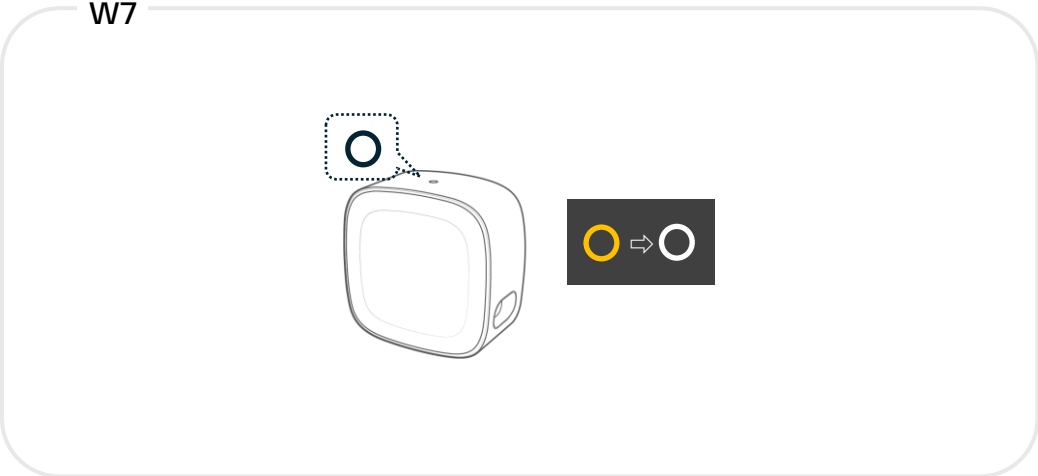

Press and hold the [O] button for more than 10 seconds.

If any component is missing or need a technical inquiry, please contact us using the information provided below.

Web Site : <https://www.lg-instore-support.com/Soundsuite>

Inquiry : rydis@rydis.co.kr / sales@rydis.co.kr

Tel : +82-70-8671-2210 / +82-70-8671-2689